



CONTINUOUS CLEANING

3-in-1 Stick Vac
Lightweight with Corded Power

Model EV1426CS

USER GUIDE

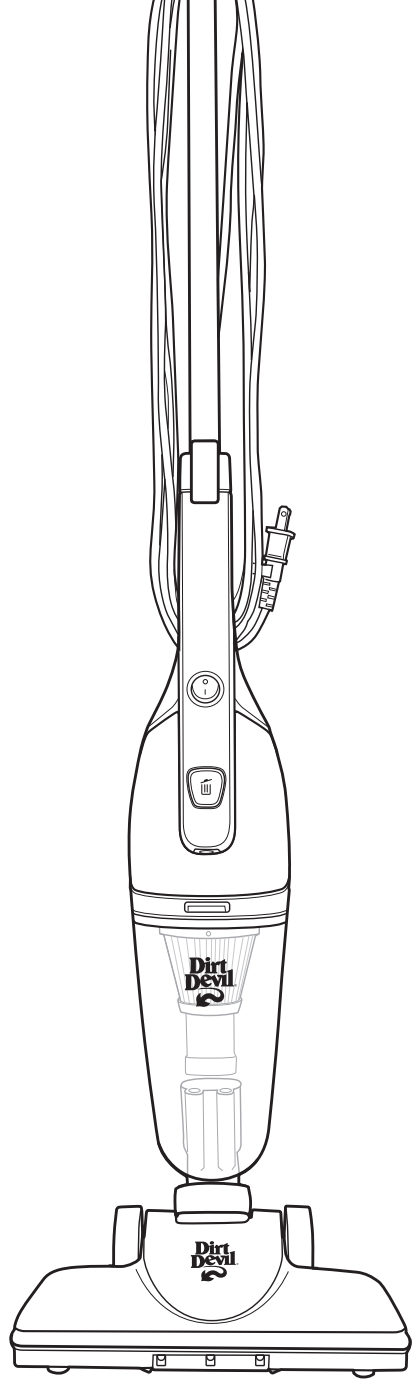

Thank you for choosing Dirt Devil!

PLEASE READ BEFORE RETURNING THIS PRODUCT FOR ANY REASON.

IMPORTANT SAFETY NOTIFICATIONS

**Before operating the Vacuum cleaner,
please read all safety and operating instructions.
Save all instructions in a safe place for future reference.**

DEFINITIONS: Safety Alert Symbols and Words

This instruction manual uses the following safety alert symbols and words to alert you to hazardous situations and your risk of personal injury or property damage.

 **DANGER:** Indicates an imminently hazardous situation which, if not avoided, **could** result in death or serious injury.

 **WARNING:** Users of this product are cautioned not to make modifications or changes that are not approved by ePro USA, LLC, doing so may void the compliance of this product.

 **CAUTION:** Indicates a potentially hazardous situation which, if not avoided, **may** result in minor or moderate injury.

 **ATTENTION:** Alerts the user to the presence of important operating and maintenance instructions for this appliance.

 (Used without word) Indicates a safety related message.

NOTICE: Indicates a practice **not related to personal injury** which, if not avoided, **may** result in property damage.

 **WARNING: Read all safety warnings and all instructions.**
Failure to follow the warnings and instructions may result in electric shock, fire and/ or serious injury.

 **WARNING:** Never modify the product or any part of it. Damage or personal injury could result.

 **WARNING:** To reduce the risk of injury, read the instruction manual.

 **WARNING:** Do not alter the plug in any way. If the plug does not fit fully in the outlet, reverse the plug. If it still does not fit, contact a qualified electrician to install the proper outlet.

 **WARNING:** Before assembling or disassembling the accessories always ensure that the appliance has been unplugged from the wall outlet! Make sure that the appliance is switched off and unplugged.

 **WARNING:** This product can expose you to chemicals including Lead, which is known to the State of California to cause reproductive harm. For more information go to www.P65Warnings.ca.gov

IMPORTANT SAFETY NOTIFICATIONS

When using an electrical appliance, basic precautions should always be followed, including the following:

⚠ WARNING: To reduce the risk of fire, electrical shock or injury:

- Shock Hazard. Do not put the vacuum in water or other liquid.
- Use only as described in this manual. Use only manufacturer's recommended attachments.
- Do not use with damaged cord or plug. If appliance is not working as it should, has been dropped, damaged, left outdoors, or dropped into water, return it to a service center or dispose of it according to your local waste and disposal guidelines.
- Do not pull or carry by cord, use cord as a handle, close a door on cord, or pull cord around sharp edges or corners. Do not run appliance over cord. Keep cord away from heated surfaces.
- Do not unplug by pulling on cord. To unplug, grasp the plug, not the cord.
- Do not allow the cord to hang over the edge of a table or counter or touch hot surfaces. The unit should be placed or mounted away from sinks and hot surfaces.
- Do not put any object into openings. Do not use with any opening blocked; keep free of dust, lint, hair, and anything that may reduce air flow.
- Keep hair, loose clothing, fingers, and all parts of body away from openings and moving parts.
- Do not use to pick up flammable or combustible liquids, such as gasoline, or use in areas where they may be present.
- Do not pick up anything that is burning or smoking, such as cigarettes, matches, or hot ashes.
- Do not pick up toxic material (i.e. chlorine bleach, ammonia, drain cleaner, etc.)
- Do not vacuum toner (for laser printer, copy machines etc.) as there is a risk of fire and explosion.
- Do not vacuum plaster, cement etc. as the filter can become blocked.
- Do not use the vacuum without all the filters fitted.
- Do not operate outdoors. This appliance is intended for household use only and not for commercial or industrial use.
- Do not operate on wet floor or moist conditions, e.g bathroom. Water and moisture could damage the circuit board.
- Do not handle plug with wet hands.
- Use extra caution when cleaning on stairs.
- Plug the plug directly into an electrical outlet.
- Use the plug only in a standard electrical outlet (120V/60Hz).
- Unplug the plug from outlet before any routine cleaning or maintenance.
- Do not look into the air vents when the unit is switched on, as sometimes small debris can be discharged, especially after cleaning or replacing the filter.
- Do not leave appliance unattended when plugged in.
- Do not allow appliance to be used as a toy. Close attention is necessary when used by or near children.
- Turn off the switch before unplugging

* **Polarized Plugs** (one blade is wider than the other) are used on equipment to reduce the risk of electric shock. When provided, this plug will fit in the polarized outlet only one way.

ADDITIONAL SAFETY WARNINGS

WARNING:

- **Prevent unintentional starting.** Ensure the switch is in the off-position before picking up or carrying the appliance.
- **Have servicing performed by a qualified repair person using only identical replacement parts.**
This will ensure that the safety of the product is maintained.
- **Do not modify or attempt to repair the appliance except as indicated in the instructions for use and care.**
- **Do not store or use the appliance near high temperature areas.**
- **To prevent tripping accidents, store vacuum after each use.**
- **Do not expose the vacuum to outdoor elements.**
- **Do not place any object on top of the product or place the product on a soft surface that might block the ventilation slots and result in excessive internal heat.** Place the product in a position away from any heat source. The charging circuit is ventilated through slots in the left and the right of the housing.
- **Do not operate the product with a damaged cord or plug.**
- **Do not operate the product if it has received a sharp blow, been dropped or otherwise damaged in any way.**
- **Do not disassemble the product; take it to an authorized service center when service or repair is required.**
Incorrect reassembly may result in a risk of electric shock, electrocution or fire.
- **Disconnect the plug from the outlet before attempting any cleaning. This will reduce the risk of electric shock.**
- **If the vacuum requires cleaning, unplug the plug, switch off the unit.**
Do not use cleaners or solvents to clean the exterior of the vacuum. Use only a damp or dry cloth.
- **For safety reasons, this vacuum is designed to power off if the motor overheats.** If this occurs, please switch the power off and unplug the unit to allow the motor to cool down before using again.

GOOD TO KNOW

HELPFUL HINTS

- **DO** empty the dust bin and clean the filters regularly for optimal operation of the vacuum.
- **DO** keep hair, loose clothing, fingers, feet and body parts away from openings or moving parts.
- **DO** disconnect the appliance from the mains supply before storing.
- **DO** turn off controls before you connect or disconnect the appliance to or from the power supply.
- **DO** disconnect the appliance from the power supply when not in use, before changing the filters, cleaning the filters or connecting/disconnecting the accessories.
- **DO** use only on dry, indoor surfaces.
- **DO** use only as described in this manual. Use only manufacturer's recommended attachments.
- **DO** keep cord away from heated surfaces.
- **DO** keep all openings free of dust, lint, hair, and anything that may reduce airflow.
- **DO** use extra care when vacuuming on stairs.
- **DO** keep your work area well lit.
- **DO** ensure children and babies cannot play with plastic bags or any packaging materials.
- **DO** operate the appliance from a power source of the same voltage, frequency and rating as indicated on the product identification plate.
- If this appliance is used by a third party, **DO** supply the instruction manual with it. No liability can be accepted for any damage caused by non-compliance with these instructions or any other improper use or mishandling of appliance. This product has not been designed for any uses other than those specified in this manual.
- **DO NOT** modify the polarized plug to fit a non-polarized outlet or extension cord.
- **DO** keep appliance on a level surface.
- **ONLY** for domestic use. Industrial or commercial use invalidates the warranty.

DO NOT RETURN TO STORE

Contact ePro Support for assistance with your vacuum.

**SCAN TO VISIT
SUPPORT PAGE**



For assistance with your product,
please email service@eproselect.com
or visit our support page:
<https://www.eproselect.com/dirtdevil-support>



GIVE US A CALL!
1-877-858-EPRO (3776)

The Dirt Devil logo and DIRT DEVIL are registered trademarks of Techtronic Cordless GP and used under license.

GETTING TO KNOW YOUR 3-in-1 VACUUM

LOCATION OF CONTROLS

- 1 Handle
- 2 Detachable Dust Bin
- 3 HEPA F9 Filter
- 4 Main Body
- 5 Hand Vac LED Light
- 6 Dust Bin Release Button
- 7 ON/OFF Switch
- 8 Lock Switch
- 9 Floor head with Easy-glide Wheels
- 10 Floor head LED Lights
- 11 Soft Brush Tool
- 12 Crevice Tool
- 13 Accessory Pole Clip

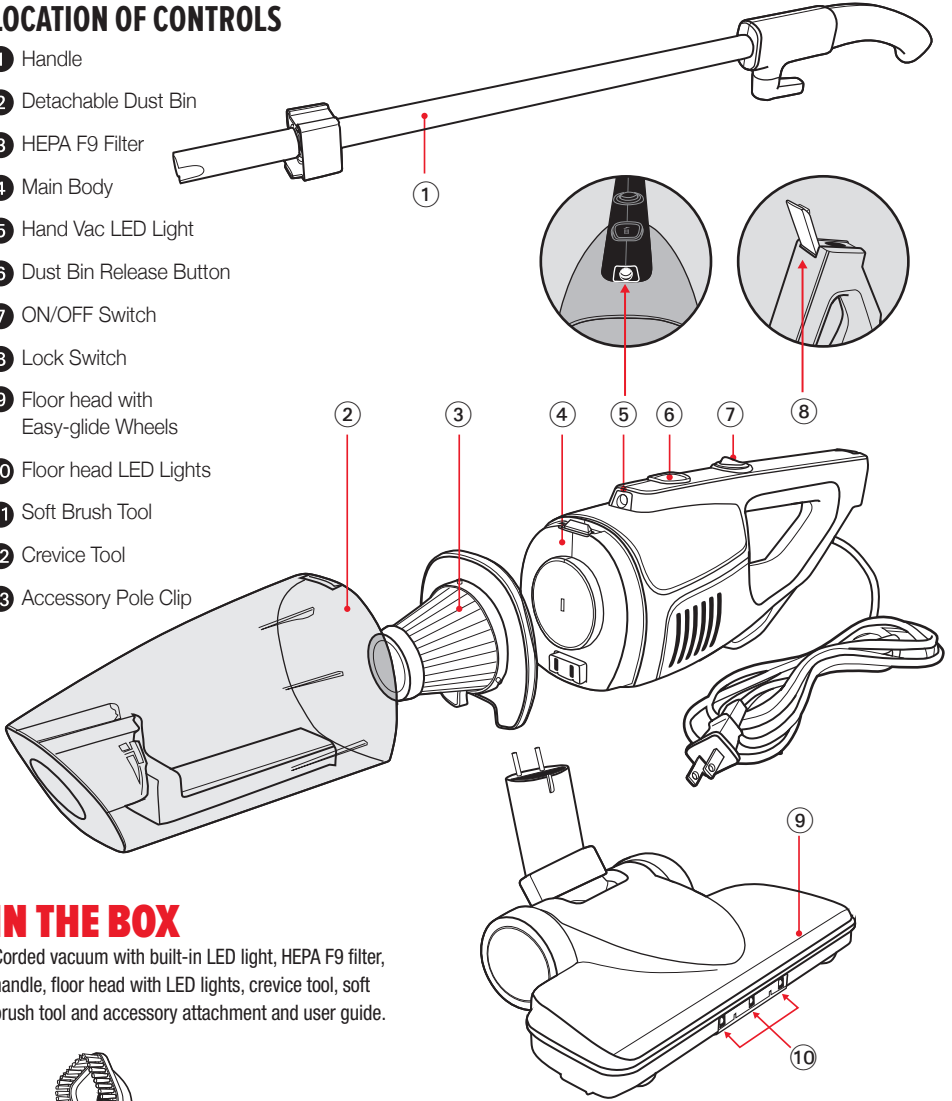

IN THE BOX

Corded vacuum with built-in LED light, HEPA F9 filter, handle, floor head with LED lights, crevice tool, soft brush tool and accessory attachment and user guide.

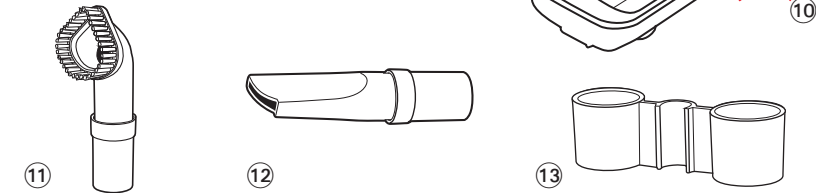

CAUTION: Do not plug in your vacuum cleaner until you are familiar with all instructions and operating procedures.

ASSEMBLY



CAUTION: Always disconnect the appliance from the electric outlet before assembling or disassembling unit or accessories.

- 1 Insert the end (A) of the handle into the main body. Then, lift lock switch (B) upward until you hear a "click" (C) to secure handle.

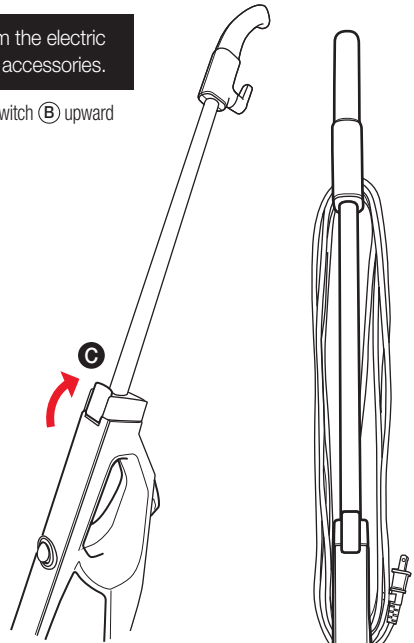
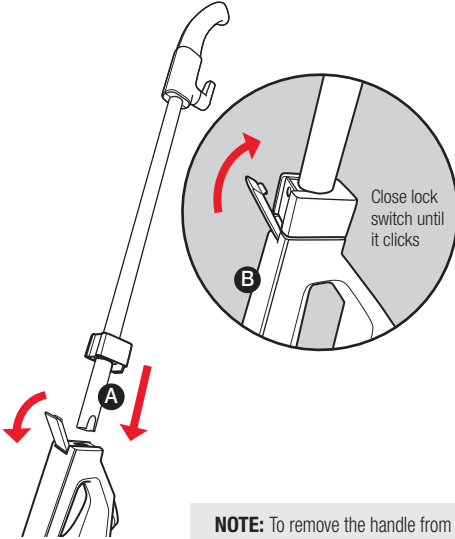

NOTE: To remove the handle from the main body, pull the lock switch outwards and pull the handle assembly out of the main body.

- 2 Attach the FLOOR HEAD to the open end of the dust bin (A) aligning the two pins (B) to the holes. Proper connection is needed to operate the LED lights and floor head for carpeted and hard surface floors.

TO DISCONNECT, unplug unit from power outlet and remove the floor head by pulling it apart from the dust bin.

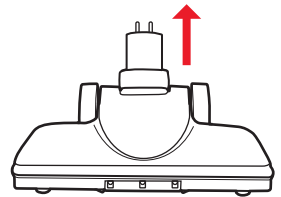
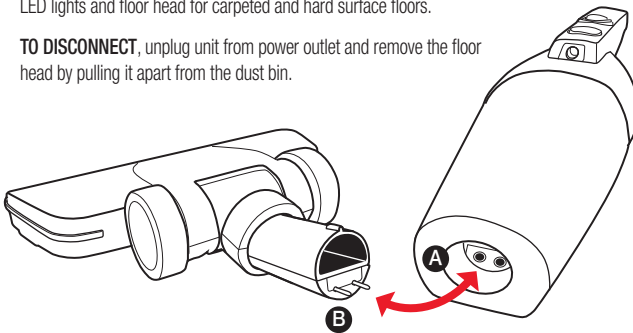

CAUTION: Wrapping the cord too tightly with excessive stress on the cord may cause cord damage. A damaged cord is an electrical shock hazard and could cause personal injury or damage.

OPERATING INSTRUCTIONS

TO USE AS A FLOOR VACUUM

- 1 Assemble all parts and include the floor head.
- 2 Plug the assembled floor vacuum into a standard AC outlet.
- 3 Operate the floor vacuum in slightly angled back or in swivel mode right or left to easily maneuver under or around furniture and obstacles.

NOTE: Three bright LED lights on floor head help illuminate the cleaning path while operating.

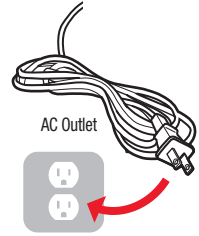
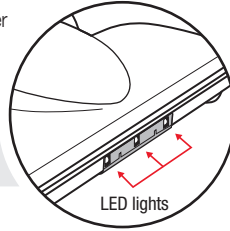

TO USE AS A HAND VACUUM

- 1 Ensure the appliance is switched OFF and unplugged from the power outlet.
- 2 Release the **LOCK SWITCH** (A) away from pole and remove the handle (B) from the main body upward.
- 3 **REMOVE** the floor head from the main body.
- 4 Plug back into the AC power outlet with or without the crevice tool or brush attachment.
 - Use the appliance as a handheld vacuum cleaner to clean couches, stairs and hard-to-reach places.
 - Switch between the crevice tool and brush tool for small crevices or upholstered surfaces.

NOTE: A built-in LED beam helps illuminate dark corners, car interior and other spaces devoid of light.

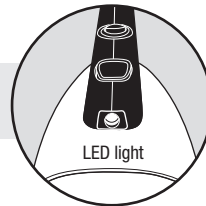
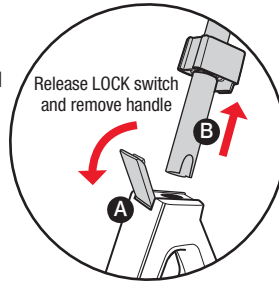

MULTI-SURFACE VACUUM

- 1 Unplug vacuum before converting handheld vacuum to multi-surface vacuum for stairs and other flat areas.
- 2 Reattach the floor head (C) without the long handle.
- 3 Plug into AC outlet near stairs, or other level surface areas.

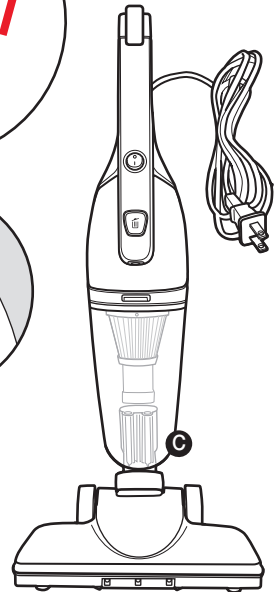

ATTENTION: Do not allow the vacuum to remain in one spot for any length of time when the brush roller is turning. Damage to carpet may occur.



WARNING: Do not alter the plug in any way. If the plug does not fit fully in the outlet, reverse the plug.

OPERATING INSTRUCTIONS

ACCESSORY ATTACHMENTS

- 1 Use the provided CREVICE TOOL for narrow suction dirt and debris between cushions, in corners, and along wall and counter-top edges. Can be used on blinds, lamp shades, vents and other narrow areas.
- 2 Use the SOFT BRUSH attachment on fabrics, curtains, cushions and more delicate surfaces. Avoid adding pressure to allow the brush to help with the suction on textiles.



Crevice Tool

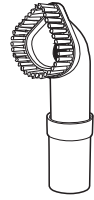

Brush Tool

NOTE: Can also use soft brush or crevice tools attached to the long handle for high places, draperies, blinds and walls.

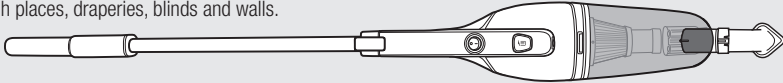

CLEANING AND MAINTENANCE

EMPTYING AND CLEANING

To achieve the best performance, empty the dust bin and clean the dust bin filter after every use. Always switch off and unplug the appliance from the ac power outlet before any maintenance or cleaning.

- Clean the outside of the appliance and inside the dust bin with a damp cloth. Dry thoroughly before use.
- Never immerse the appliance in the water.

! If suction power seems to diminish, it may be time to empty the dust bin or clean or replace the filter.

- 1 **TO REMOVE THE DUST BIN**, press down on the dust bin release button (A) and pull off over a trash can trash bag.
- 2 Pull off the dust bin filter (B).
- 3 Empty the debris from the dust bin.
- 4 Clean the unattached dust bin filter and dust bin under running water. Dry thoroughly. Do not use abrasive or chemical cleaning agents.
- 5 Replace the dust bin filter (B) back into the dust bin.

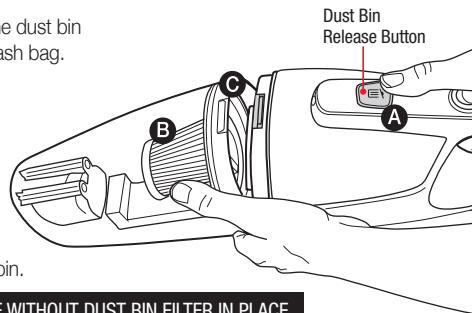

! **WARNING:** NEVER OPERATE THE APPLIANCE WITHOUT DUST BIN FILTER IN PLACE.

- 6 Reattach the dust bin to the main body until tab (C) clicks into place.

! **CAUTION:** Before assembling or disassembling unit and accessories, always ensure that the appliance has been unplugged from the wall outlet! Make sure that the appliance is switched off and unplugged.

! **WARNING:** Do not operate cleaner with damp or wet filters or without filter in place.

TROUBLESHOOTING

OBSERVATION	POSSIBLE CAUSE	SOLUTION
Vacuum does not work	<ul style="list-style-type: none"> • Power adapter not plugged into wall outlet securely • Check if the appliance is switched on • Electric wall outlet does not have power 	<ul style="list-style-type: none"> • Make sure the unit's power cable is securely plugged into the wall outlet. • Ensure unit power button is switched on • Plug the unit into a different outlet
Suction power becomes weak	<ul style="list-style-type: none"> • Check if the appliance is clogged or damaged • Check if the dust bin is full • Check if the dust bin filter needs cleaning 	<ul style="list-style-type: none"> • Immediately remove the obstruction • Turn unit off and unplug the appliance from the wall outlet and empty the dust bin • Clean the dust bin filter
Vacuum cleaner is overheating	Check that the appliance is not blocked	<ul style="list-style-type: none"> • Turn unit off and unplug the appliance from the wall outlet. Remove dust bin filter and check for objects in the air intake opening and remove obstruction
Dust is coming out of the vacuum cleaner	<ul style="list-style-type: none"> • Check if the dust bin is full • Check that the dust bin is properly fitted to the main body • Check if the dust bin filter is in the dust bin 	<ul style="list-style-type: none"> • Empty and clean dust bin • Refit the dust bin to the main body • Install the filter in the dust bin



For safety reasons, this vacuum is designed to power off if the motor overheats. If this occurs, please switch the power off and unplug it to allow the motor to cool down before using again.

PRODUCT DIMENSIONS (WDH):

- Handle and floor head assembled: 9.6" x 6.8" x 43.2"
- Hand vacuum only: 4.3" x 5.4" x 17.9"

TECHNICAL SPECIFICATIONS

Power Consumption: **400W**
 Vacuum Capacity: **700ml**
 Sound level: **85dBA**
 Motor Rated voltage: **AC 120V**
 Cord Length: **15 feet**

For additional help contact ePro Support for assistance with your vacuum.

SCAN TO VISIT SUPPORT PAGE



For assistance with your product, please email service@eproselect.com or visit our support page: eproselect.com/dirtdevil-support



GIVE US A CALL!
1-877-858-3776

The Dirt Devil logo and DIRT DEVIL are registered trademarks of Techtronic Cordless GP and used under license.

TERMS AND CONDITIONS

1-YEAR LIMITED END USER WARRANTY

ePro USA LLC., (the "Company") warrants that their products (the "Product") are free of defects in material and workmanship for a period of 1-YEAR (the "Warranty Period") from the date of purchase by end user. In the event that the Product qualifies for coverage under this warranty, the Company at its option and at no charge may either repair or replace the Product (not including, shipping, handling, delivery or installation) with an identical product or product having similar features and functionality as determined by the Company. The Company does not warranty the installation, maintenance, or service of its Product. The Company is not responsible for ancillary equipment not supplied by the Company, which is attached to or used in connection with the Company's Product, or for the operation of the Product with any ancillary equipment, and all such equipment and operation of such equipment with the Product, is expressly excluded from this limited warranty. Furthermore, the Company shall not be responsible for any damage to the Product resulting from the use or operation of the ancillary equipment not furnished by the Company for use with the Product.

The Company extends this limited warranty only to the original end-user. This limited warranty and the remedies hereunder are limited to Products properly used, maintained, stored, installed and used for their intended purpose and use only, in accordance with the Company instructions. This warranty shall not apply to Product installed, operated or maintained in or under abnormal conditions. This warranty is not applicable to any Product, which is not operated and/or installed in accordance with the Company's specifications and or industry practices and standards. This warranty does not extend to any battery power supply included in/with the Product.

This warranty also does not extend to the purchase of opened, used, repaired, repackaged and/or resealed products, including but not limited to sale of such products on Internet auctions sites and/or sales of such products by surplus, bulk resellers, or any individual unauthorized resellers.

Any and all warranties or guarantees shall immediately cease and terminate as to any products or parts thereof which are repaired, replaced, altered, or modified, without the prior express and written permission of the Company.

This warranty sets forth all of the Company's responsibilities for the Product.

THIS WARRANTY IS GIVEN IN LIEU OF ALL OTHER EXPRESS WARRANTIES. IMPLIED WARRANTIES, STATUTORY OR OTHERWISE, INCLUDING BUT NOT LIMITED TO ANY IMPLIED WARRANTIES OF MERCHANTABILITY OR FITNESS FOR A PARTICULAR PURPOSE, ARE LIMITED TO THE DURATION OF THIS LIMITED WARRANTY. IN NO EVENT, INCLUDING WITHOUT LIMITATION, IN CONTRACT, TORT, STRICT LIABILITY OR WARRANTY, SHALL THE COMPANY BE LIABLE TO THE PURCHASER OR TO ANY THIRD PARTY, FOR ANY DAMAGES OR FOR ANY LOSS OF USE, LOSS OF TIME, LOSS OF LIFE, INCONVENIENCE, COMMERCIAL LOSS, LOST PROFITS OR SAVINGS OR INCIDENTAL, CONSEQUENTIAL OR SPECIAL DAMAGES ARISING OUT OF THE USE OR INABILITY TO USE SUCH PRODUCT. TO THE FULL EXTENT THAT SUCH MAY BE DISCLAIMED BY LAW, COMPANY'S SOLE LIABILITY SHALL BE TO REPLACE OR REPAIR THE PRODUCT.



WARNING: This product can expose you to chemicals including Lead, which is known to the State of California to cause reproductive harm. For more information go to www.P65Warnings.ca.gov



This device complies with part 15 of the FCC Rules. Operation is subject to the following two conditions: (1) This device may not cause harmful interference, and (2) this device must accept any interference received, including interference that may cause undesired operation.

If you have any questions or for further support, please email us at service@eproselect.com



Intertek
5025829

CONFORMS TO UL STD.
1017

CONFORMS TO CSA STD.
C22.2 #243

**SCAN TO VISIT
SUPPORT PAGE**



For More Information

For assistance with your product, please email
service@eproselect.com, call **1-877-858-EPRO (3776)**
or visit **<https://www.eproselect.com/dirtdevil-support>**

PLEASE RECYCLE Facilities may not exist in your area.



MADE IN CHINA

Distributed by ePro USA LLC. Austin, TX ©2024 ePro USA LLC. All rights reserved.

The Dirt Devil logo and DIRT DEVIL are registered trademarks
of Techtronic Cordless GP and used under license.